

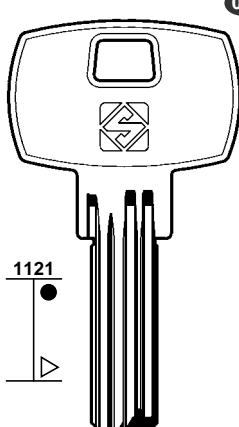









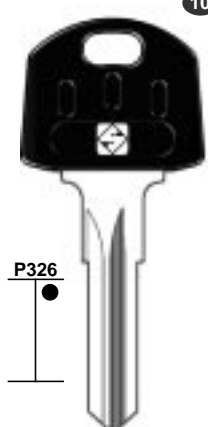



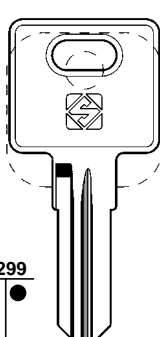

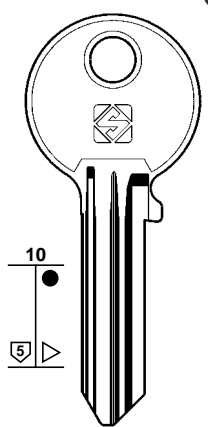

PER: FOR:	ALPHA	ABUS	BMB
	 <p>06</p> <p>1121</p> <p>ALP16</p>  	 <p>10</p> <p>P326</p>  <p>AB64RAP U72</p>  	 <p>04</p> <p>1299</p> <p>BMB1</p> 

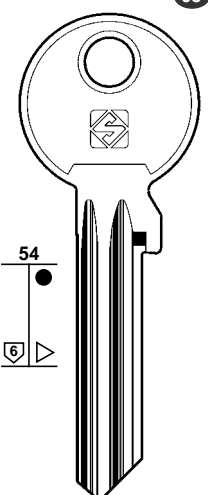

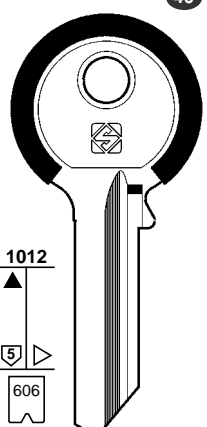
1

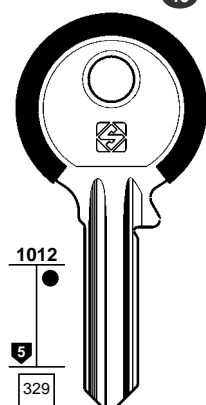
PER / FOR
ALPHA (J)
ABUS (D) +  CISA (1)
BMB (D)
CISA (I) +  ABUS (1)
EVVA (A)
FAB (CZ)
ISEO (I)

PER: FOR:	CISA	EVVA	FAB	ISEO
	 <p>02</p> <p>10</p> <p>CS138 G08D</p> 	 <p>05</p> <p>54</p> <p>EV81X</p> 	 <p>40</p> <p>1012</p> <p>606</p> <p>FB22RAZ</p> <p>..... 1-2-3-4-5-6-7-8</p> 	 <p>40</p> <p>1012</p> <p>329</p> <p>IE3AZ</p> <p>..... 1-2-3-4-5-6</p> 

01

COMMERCIAL GROUP
GRUPPO COMMERCIALE
PREISEGRUPPE
GROUPE COMMERCIAL
GRUPO COMMERCIAL

www.silca.it



2

PER / FOR

TOKOZ (CZ)

TRELOCK (D)

TRIOVING (N)

VACHETTE (F)

PER: TOKOZ

FOR:

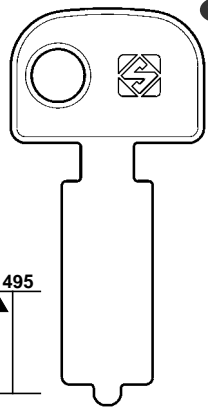

TOZ2



PER: TRELOCK

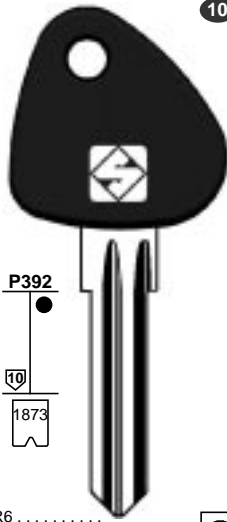

R6
0-1-2

TRK1P



PER: TRIOVING

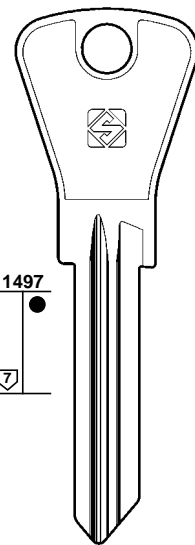

TR14

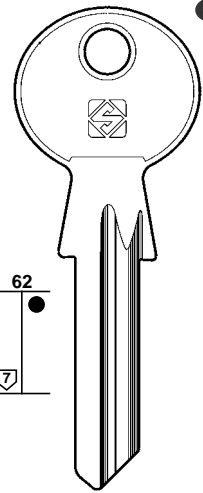

TR15

PER: VACHETTE

FOR:

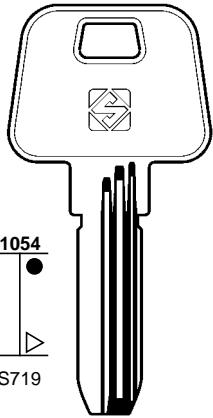

VAC150
V6



PER:

FOR:

01

COMMERCIAL GROUP
GRUPPO COMMERCIALE
PREISEGRUPPE
GROUPE COMMERCIAL
GRUPO COMMERCIAL

www.silca.it

Specialist's Guide

PER:
FOR: **FICHET (F)**

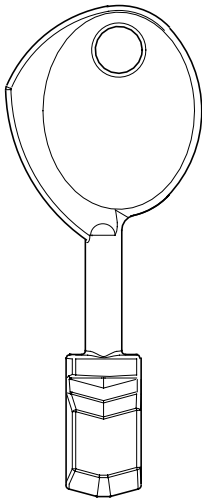

(787)

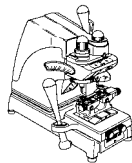

MATRIX SX - SLX

OPTIONAL

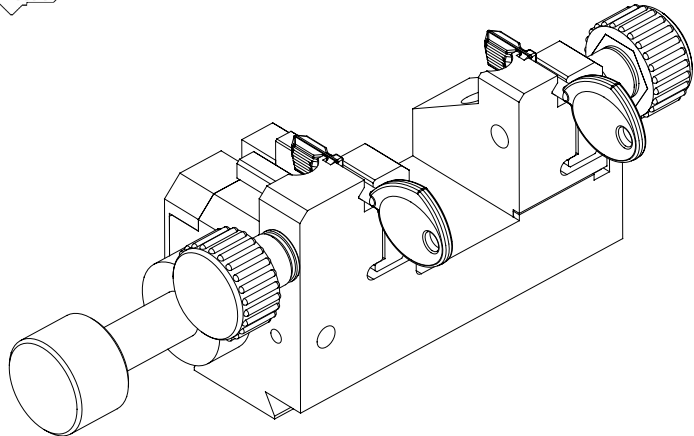

NEW

D725483ZB

Clamp for Fichet type keys
Morsetto per chiavi tipo Fichet
Spannbacken für Fichet Schlüsseltyp
Etau pour clés de type Fichet
Mordaza para llaves de tipo Fichet



D725731ZB

Tracer point T62
Tastatore T62
Taster T62
Palpeur T62
Palpador T62

D725730ZB

Cutter F62W
Fresa F62W
Fräser F62W
Fraise F62W
Fresa F62W

PER:
FOR: **TOKOZ (CZ)**

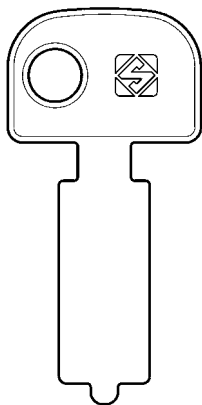

TOZ2

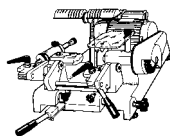

TECH 3

OPTIONAL

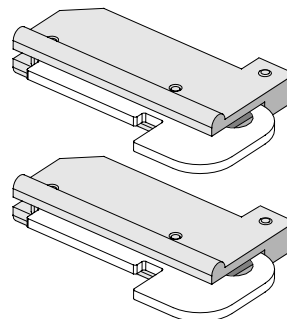

NEW

D726431ZB

Adaptors for TOKOZ keys
Adattatori per chiavi TOKOZ
Adapters für TOKOZ Schlüssel
Adaptateurs pour clés TOKOZ
Adaptadores para llaves TOKOZ

Delivery time DECEMBER 2003
Disponibilità DICEMBRE 2003
Lieferbar DEZEMBER 2003
Disponibilité DÉCEMBRE 2003
Disponibilidad DICIEMBRE 2003



Prima Laser Code Program

UPDATE 1/2003 - AGGIORNAMENTO 1/2003
 UPDATING 1/2003 - MISE A JOUR 1/2003 - ACTUALIZACIÓN 1/2003

<i>S.S.N.</i>	<i>LOCK/SYSTEM SISTEMA/SERRATURA SCHLOSS/SYSTEM SYSTÈME SERRURE SISTEMA CERRADURA</i>	<i>SILCA REF. ARTICOLO SILCA SILCA ROHLING ARTICLE SILCA ARTICULO SILCA</i>	<i>APPLICATION UTILIZZO VERARBEITER UTILISATION UTILIZACION</i>	<i>JAW MORSETTO SPANNBACKEN ETAU MORDAZA</i>	<i>NOTE NOTE HINWEIS NOTE ANOTACIONES</i>
328	MUEL 10 GORGES	MU10-1 ... 10	VARIOUS	D2	-
329	MUEL 8 GORGES	MU8-1 ... 8	VARIOUS	D2	-
346	SECUREMME (5SCM10)	5SCM10	VARIOUS	D1	-
347	SECUREMME (5SCM8)	5SCM8	VARIOUS	D1	-
348	FICHET (ORIGINAL)	ORIGINAL	VARIOUS	D1	-
349	LIPS VAGO (ORIGINAL)	ORIGINAL	VARIOUS	D1	-
350	FIAMCA (ORIGINAL)	ORIGINAL	VARIOUS	D1	-
351	CONFORTI (ORIGINAL)	ORIGINAL	VARIOUS	D1	-
352	MUEL 7 GORGES	ORIGINAL	VARIOUS	D2	-
359	TRIO VING 140 SERIES	6TR3	VARIOUS	D3	-
360	TRIO VING 40 SERIES	6TR3	VARIOUS	D3	-

